



C2363EGS

23MM SLIDING SYSTEM

C2363EGS

23MM SLIDING SYSTEM

KEY FEATURES

- Premium Quality Aluminum Profiles
- European design
- Glazing from 5mm to 10 mm
- Single Roller Capacity 65 kg.
- Double Roller Capacity 80-120 kg.
- Smooth & Effortless in movement
- Automatic, manual concealed & Multipoint Lock System
- Provision for insect screen
- Available in Anodized, Powder Coating & Wood Finish
- Design for Small and mid size shutter sliding
- Alloy 6063-T6 Temper as per IS-6477 1983 for dimensional tolerances and IS-1285 1975 for chemical composition and mechanical properties
- Dust Resistance & Better Sound Reduction

TWO TRACK SYSTEM

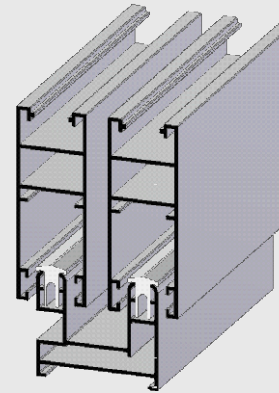

THREE TRACK SYSTEM

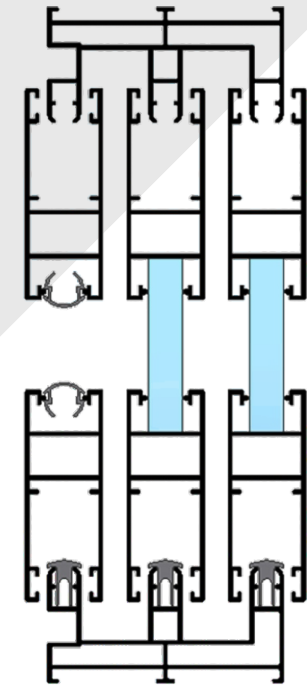
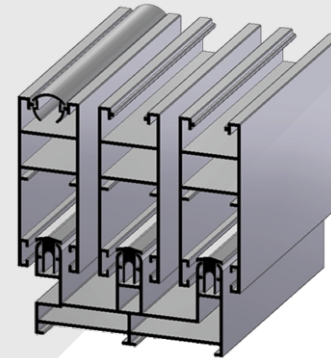

SIDE VIEW

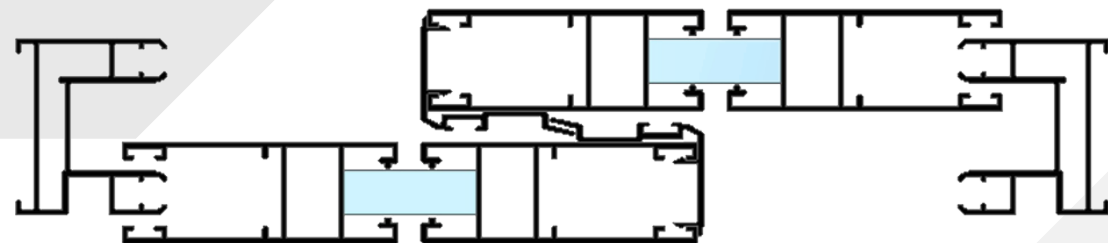

TOP VIEW



Burglar Resistance



Acoustic Performance



Wind Load Resistance



Air Tightness



Water Tightness



Impact Resistance

CARDINAL-23 TWO TRACK

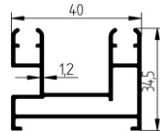
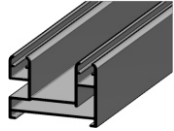

All Side Frame Section
Section Number 1203
Weight (kg/mt) 0.649

CARDINAL-23 THREE TRACK

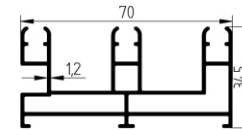
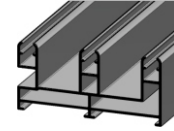

All Side Frame Section
Section Number 1206
Weight (kg/mt) 1.066

CARDINAL-23 SINGLE GLASS SHUTTER

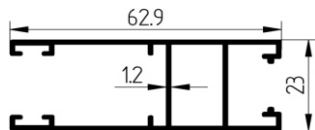
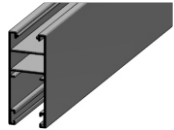

4 - 8 mm Glass Shutter
Section Number 1208
Weight (kg/mt) 0.691

CARDINAL-23 INTERLOCK CLIP

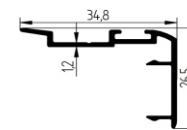
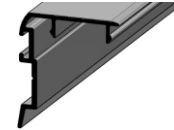

inter. Clip for Section 1208
Section Number 1207
Weight (kg/mt) 0.249

CARDINAL-23 RAIL CAP

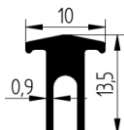
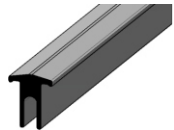

"V" Type Track Rail Cap
Section Number 1170
Weight (kg/mt) 0.131

ALUMINIUM LOCKING ROD

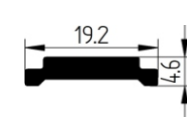
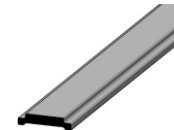

15 x 20 Euro Groove Rod
Section Number 1115
Weight (kg/mt) 0.167

MOSQUITO CLIP

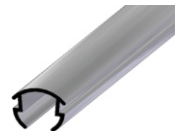

Mosquito Screen Fitting Clip
Section Number 1269
Weight (kg/mt) N/A

WHO WE ARE

Cardinal System is an exclusive aluminium door and window system brand of Laxmi Trading Company. Since 1981, LTC is engaged in supplying of highest quality aluminium sections with singular vision of our founder Shri Ghanshyambhai Patel. We are following the same vision, Cardinal Systems has evolved in to supplying one of the best quality aluminium system doors and windows across India with support of our esteem suppliers like Jindal Aluminium, Avigiri Urethane & rubber industries and many other brands.

We take pride in the long-standing relationships we have built with architects and builders along with prestigious window manufacturers. We are also working with many well-known national and international aluminium and hardware manufacturers as well India's top window manufacturers. We have maintained these relationships by providing efficient quality work from the beginning of a project through the completion. We are experienced in designing, engineering, ordering, delivering, and working closely with manufacturers.

We are supported by a dedicated team of skilled workforce that enables us in catering the requirements of the clients spread across the country. Our team comprises of procurement agents, quality controllers and others who work in proximity with each other to deliver the good within the stipulated time frame at the client's door step.

We pride ourselves on providing readily available more than 37 windows and doors system throughout the country with highest quality of aluminium extrusion and hardware through strong supply-chain management, regional warehouse and very strong after-sale support system.

OUR CAPACITY

30+ systems
ready stock available

150+ tons
of ready stock material

more than
9000 Sq.Ft.
warehousing space

CUSTOMER NETWORK

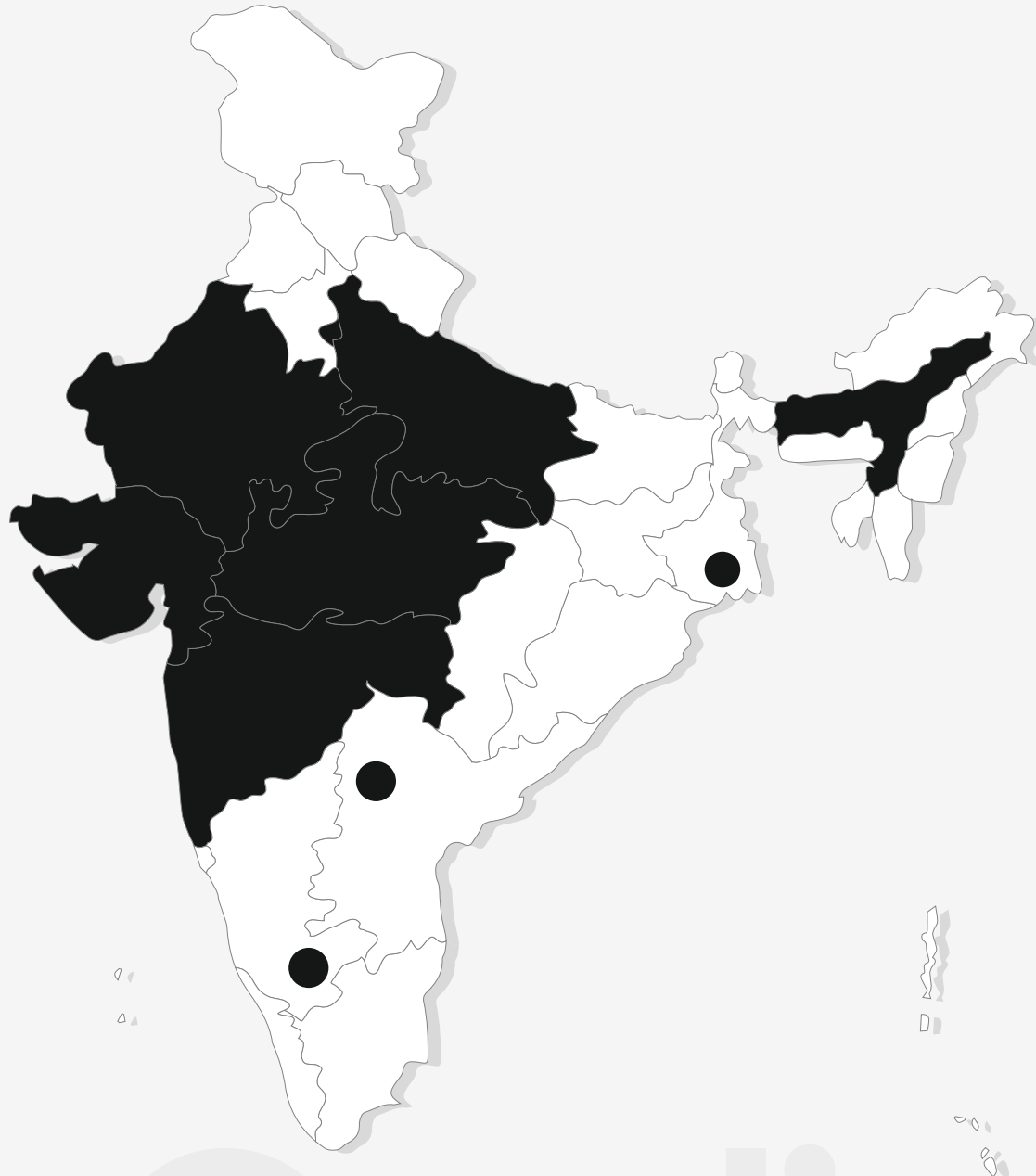

Here are the states where we are doing business

-
- Gujarat
 - Maharashtra
 - Rajasthan
 - Madhya Pradesh
 - Delhi
 - Uttar Pradesh
 - Kolkatta
 - Bangalore
 - Assam
 - Hyderabad



Since 1981



Laxmi Trading Company

15, Ashwarath Complex, Opp. Fortune Hotel,
Ashram Road, Ushmanpura, Ahmedabad - 380 013.
Gujarat, India.

Phone : (079) 27552997, (079) 27550151, (079) 48005361

Cell : +91 99240 11199, +91 9574511199

Email : info@ltcalu.com

Web : www.ltcalu.com