



C2765EGS

27MM SLIDING SYSTEM

C2765EGS

27MM SLIDING SYSTEM

KEY FEATURES

- Premium Quality Aluminum Profiles
- European design
- Glazing from 5 mm to 18 mm
- Single Roller Capacity 65 kg.
- Double Roller Capacity 110-180 kg
- Smooth & Effortless in movement
- Automatic, manual concealed & Multipoint Lock System
- Provision for insect screen
- Available in Anodized, Powder Coating & Wood Finish
- Reinforced Profiles available in larger opening with close track system
- Design for mid to large size shutter sliding
- Alloy 6063-T6 Temper as per IS-6477 1983 for dimensional tolerances and IS-1285 1975 for chemical composition and mechanical properties
- Bug & Bugler proof window
- Dust Resistance & Better Sound Reduction
- Slim interlock shutter available for single glass & double glass sliding

TWO TRACK SYSTEM

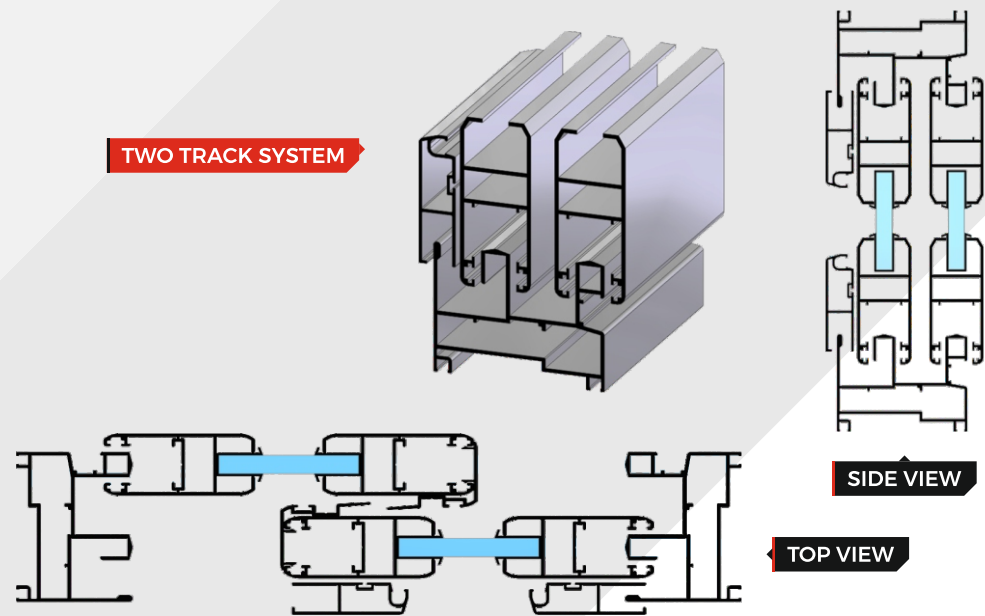

THREE TRACK WITH FLY SCREEN SHUTTER

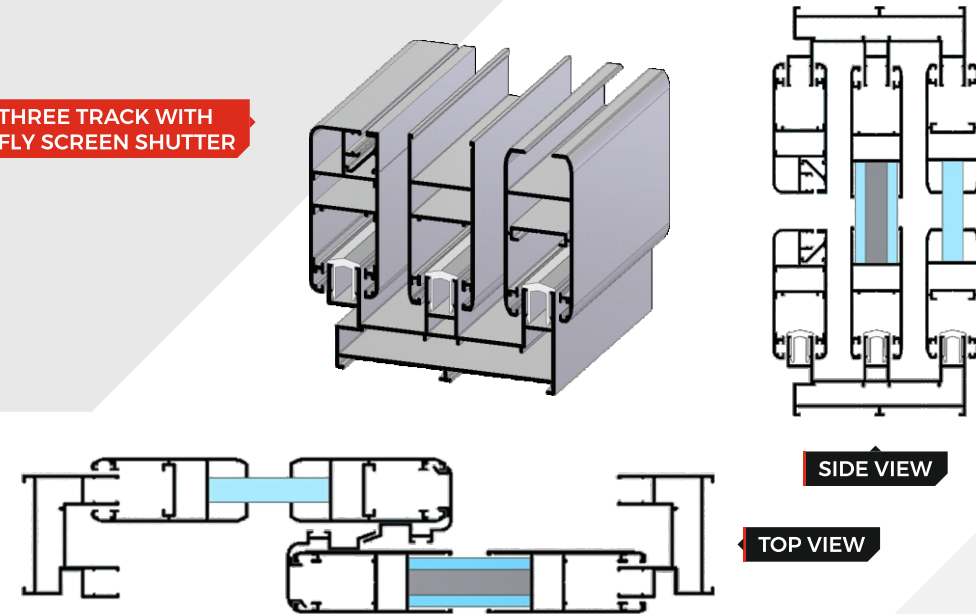

Burglar Resistance



Acoustic Performance



Wind Load Resistance



Air Tightness



Water Tightness

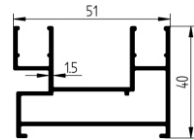
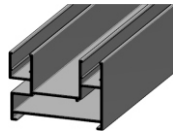

Impact Resistance

CARDINAL-27 TWO TRACK

Basic Model
 Section Number 1110
 Weight (kg/mt) 0.883

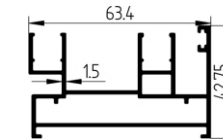
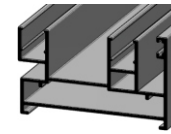
CARDINAL-27 TWO TRACK

Premium Model
 Section Number 1037
 Weight (kg/mt) 1.168

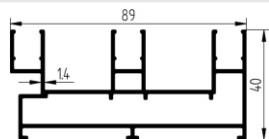
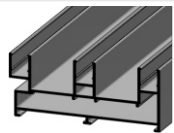
CARDINAL-27 THREE TRACK

Basic Model
 Section Number 1109
 Weight (kg/mt) 1.47

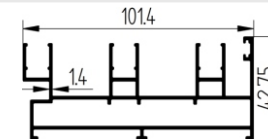
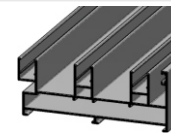
CARDINAL-27 THREE TRACK

Premium Model
 Section Number 1174
 Weight (kg/mt) 1.676

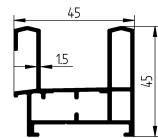
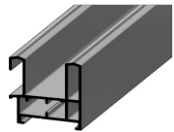
CARDINAL-27 TWO TRACK

Regular Type
 Section Number 1124
 Weight (kg/mt) 1.004

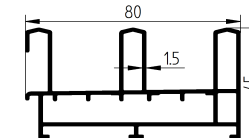
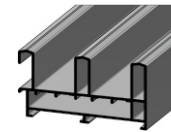
CARDINAL-27 THREE TRACK

Regular Type
 Section Number 1126
 Weight (kg/mt) 1.555

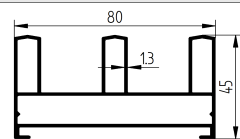
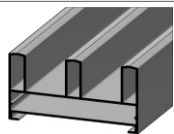
CARDINAL-27 THREE TRACK

Both End Close Section
 Section Number 1138
 Weight (kg/mt) 1.400

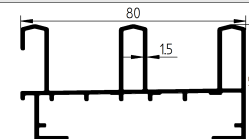
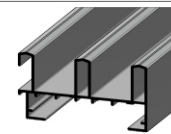
CARDINAL-27 THREE TRACK

Bottom Hollo Section
 Section Number 1137
 Weight (kg/mt) 1.337

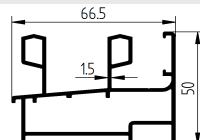
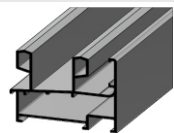
CARDINAL-27 TWO TRACK

Single Leg Section
 Section Number 1132
 Weight (kg/mt) 1.329

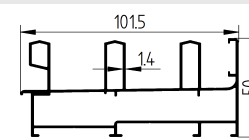
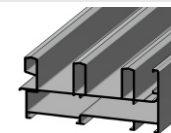
CARDINAL-27 THREE TRACK

Single Leg Section
 Section Number 1134
 Weight (kg/mt) 1.798

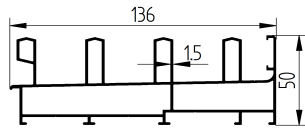
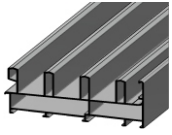
CARDINAL-27 FOUR TRACK

Single Leg Section
 Section Number 1133
 Weight (kg/mt) 2.466

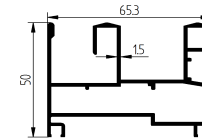
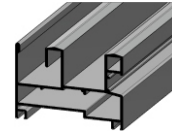
CARDINAL-27 "M" TWO TRACK

With Mosquito Shutter Option
 Section Number 1004
 Weight (kg/mt) 1.329

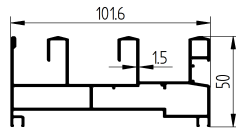
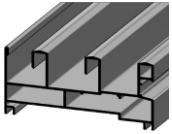
CARDINAL-27 "M" THREE TRACK

With Mosquito Shutter Option
 Section Number 1123
 Weight (kg/mt) 1.862

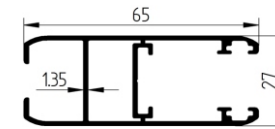
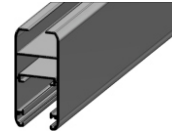
CARDINAL-27 SHUTTER

Single Glass Premium Shutter
 Section Number 1079
 Weight (kg/mt) 0.826

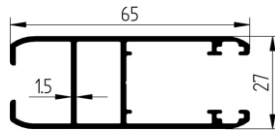
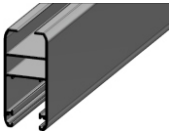
CARDINAL-27 SHUTTER

Single Glass Shutter
 Section Number 1006
 Weight (kg/mt) 0.855

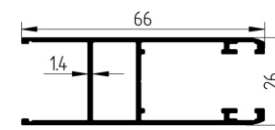
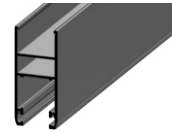
CARDINAL-27 SHUTTER

18 mm Glass Basic Shutter
 Section Number 1131
 Weight (kg/mt) 0.778

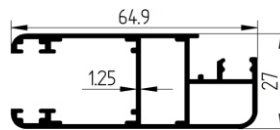
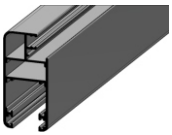
CARDINAL-27 SHUTTER

Mosquito Screen Shutter
 Section Number 1034
 Weight (kg/mt) 0.869

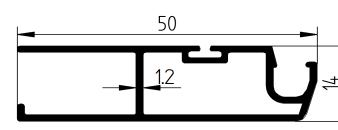
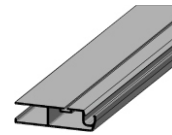
CARDINAL-27 SHUTTER

Mosquito Shutter
 Section Number 1005
 Weight (kg/mt) 0.432

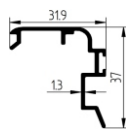
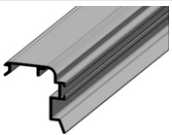
CARDINAL-27 INTERLOCK CLIP

Premium Interlock Clip
 Section Number 1080
 Weight (kg/mt) 0.339

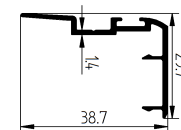
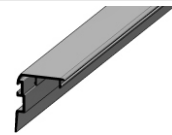
CARDINAL-27 INTERLOCK CLIP

Universal Clip
 Section Number 1001
 Weight (kg/mt) 0.303

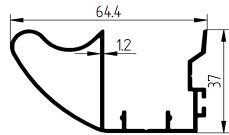
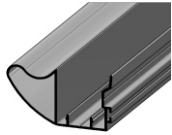
CARDINAL-27 INTERLOCK CLIP

Reinforcement Interlock

Section Number 1197

Weight (kg/mt) 0.711

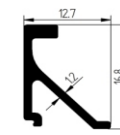
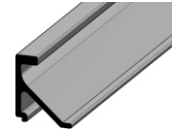
CARDINAL-27 MOSQUITO SHUTTER CLIP

Universal Clip

Section Number 1093

Weight (kg/mt) 0.14

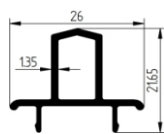
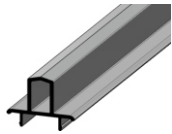
CARDINAL-27 CLIP

Meeting Section

Section Number 1129

Weight (kg/mt) 0.254

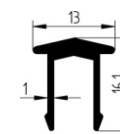
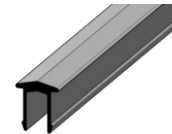
CARDINAL-27 TRACK RAIL CAP

"V" Type

Section Number 1107

Weight (kg/mt) 0.156

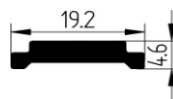
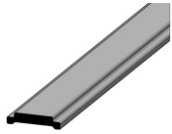
CARDINAL-27 ALUMINIUM LOCKING ROD

15 x 20 Euro Groove

Section Number 1115

Weight (kg/mt) 0.156

CARDINAL-27 MOSQUITO CLIP

Mosquito Screen Fitting Clip

Section Number 1269

Weight (kg/mt) N/A

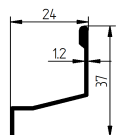
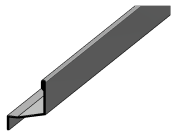
CARDINAL-27 ADDITIONAL FRAME BRACKET

With Mosquito Shutter Option

Section Number 1263

Weight (kg/mt) 0.209

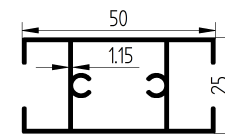
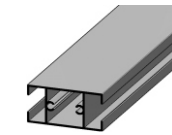
CARDINAL-27 SHUTTER MIDDLE SECTION

Single Glass Middle Shutter

Section Number 1267

Weight (kg/mt) 0.590

WHO WE ARE

Cardinal System is an exclusive aluminium door and window system brand of Laxmi Trading Company. Since 1981, LTC is engaged in supplying of highest quality aluminium sections with singular vision of our founder Shri Ghanshyambhai Patel. We are following the same vision, Cardinal Systems has evolved in to supplying one of the best quality aluminium system doors and windows across India with support of our esteem suppliers like Jindal Aluminium, Avigiri Urethane & rubber industries and many other brands.

We take pride in the long-standing relationships we have built with architects and builders along with prestigious window manufacturers. We are also working with many well-known national and international aluminium and hardware manufacturers as well India's top window manufacturers. We have maintained these relationships by providing efficient quality work from the beginning of a project through the completion. We are experienced in designing, engineering, ordering, delivering, and working closely with manufacturers.

We are supported by a dedicated team of skilled workforce that enables us in catering the requirements of the clients spread across the country. Our team comprises of procurement agents, quality controllers and others who work in proximity with each other to deliver the good within the stipulated time frame at the client's door step.

We pride ourselves on providing readily available more than 37 windows and doors system throughout the country with highest quality of aluminium extrusion and hardware through strong supply-chain management, regional warehouse and very strong after-sale support system.

OUR CAPACITY

30+ systems
ready stock available

150+ tons
of ready stock material

more than
9000 Sq.Ft.
warehousing space

CUSTOMER NETWORK

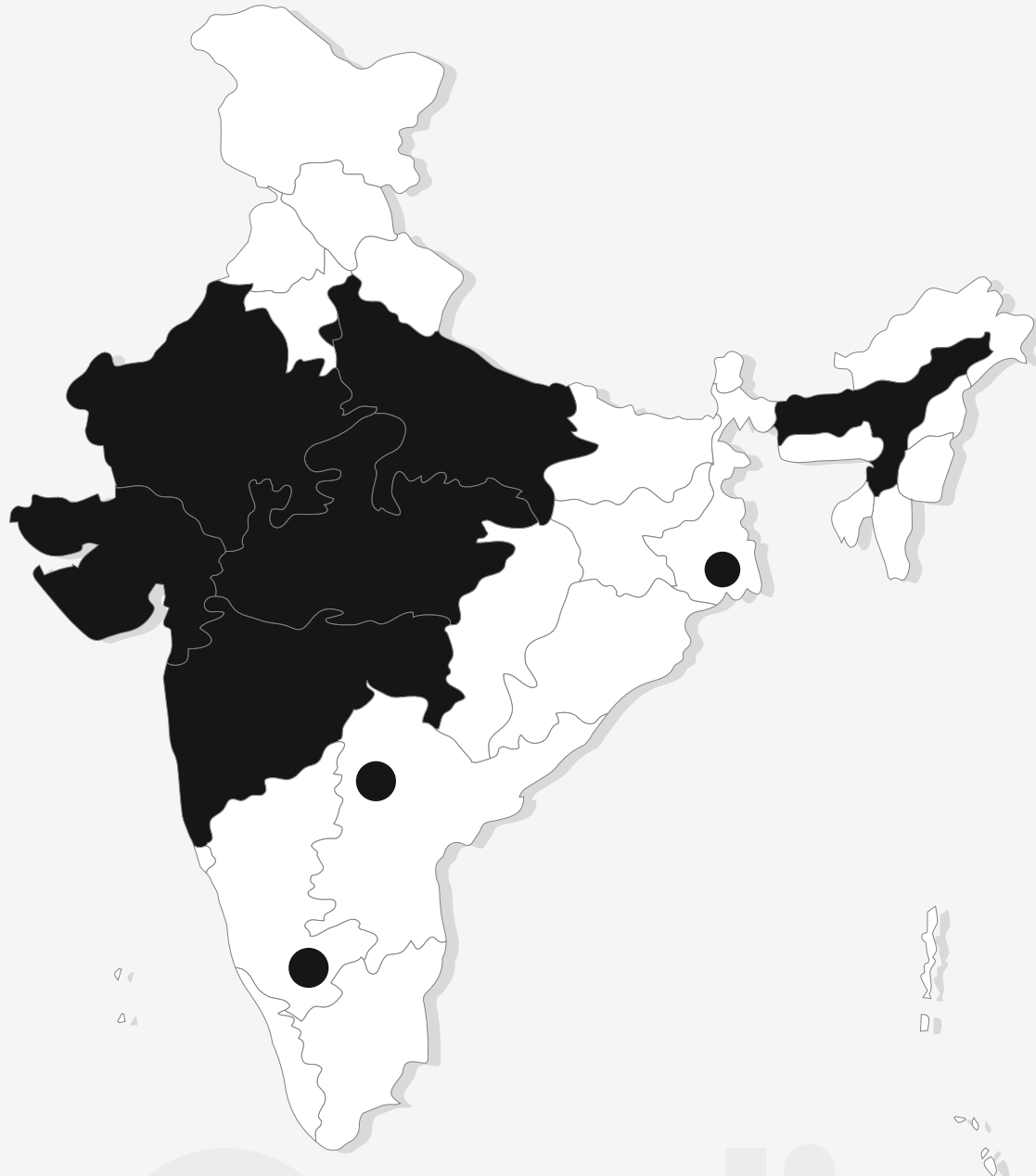

Here are the states where we are doing business

-
- Gujarat
 - Maharashtra
 - Rajasthan
 - Madhya Pradesh
 - Delhi
 - Uttar Pradesh
 - Kolkatta
 - Bangalore
 - Assam
 - Hyderabad

Cardinal



Since 1981



Laxmi Trading Company

15, Ashwarath Complex, Opp. Fortune Hotel,
Ashram Road, Ushmanpura, Ahmedabad - 380 013.
Gujarat, India.

Phone : (079) 27552997, (079) 27550151, (079) 48005361
Cell : +91 99240 11199, +91 9574511199
Email : info@ltcalu.com
Web : www.ltcalu.com