



C2965EGS

29MM SLIDING SYSTEM

C2965EGS

29MM SLIDING SYSTEM

KEY FEATURES

- Premium Quality Aluminum Profiles
- European design
- Glazing from 5 mm to 22 mm
- Single Roller Capacity 65 kg.
- Double Roller Capacity 110-180 kg.
- Smooth & Effortless in movement
- Automatic, manual concealed & Multipoint Lock System
- Provision for insect screen
- Available in Anodized, Powder Coating & Wood Finish
- Reinforced Profiles available in larger opening
- Design for Large size shutter sliding
- Alloy 6063-T6 Temper as per IS-6477 1983 for dimensional tolerances and IS-1285 1975 for chemical composition and mechanical properties
- Bug & Bugler proof window
- Dust Resistance & Better Sound Reduction
- Slim interlock shutter available for single glass & double glass sliding

TWO TRACK WITH SLIM INTERLOCK SECTION

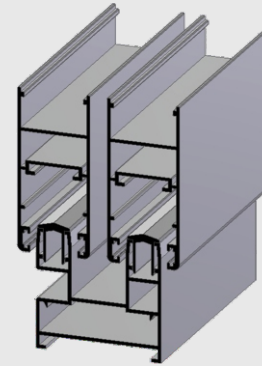

THREE TRACK WITH FLY SCREEN SHUTTER

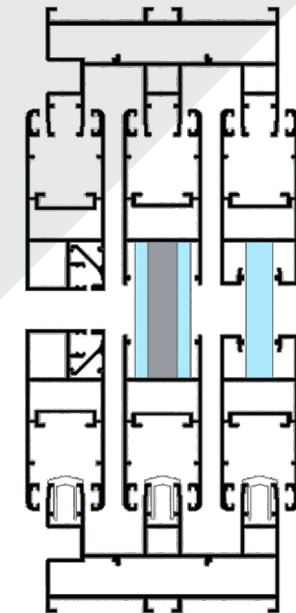
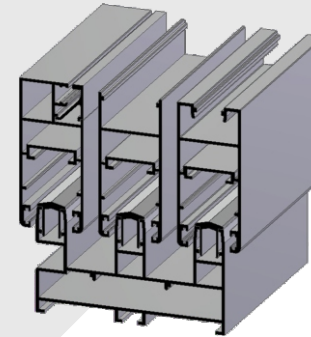

SIDE VIEW

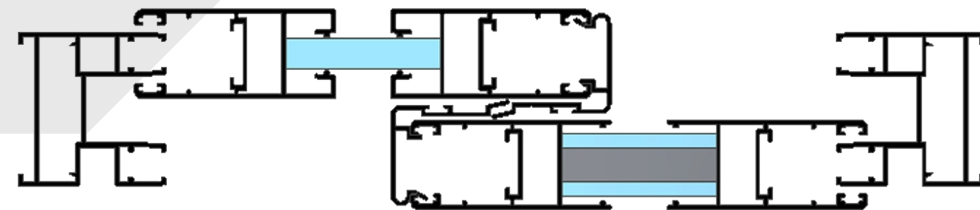

TOP VIEW



Burglar Resistance



Acoustic Performance



Wind Load Resistance



Air Tightness



Water Tightness



Impact Resistance

CARDINAL-29 TWO TRACK

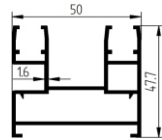
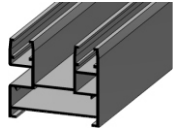

Basic Type
 Section Number 1029
 Weight (kg/mt) 1.150

CARDINAL-29 TWO TRACK

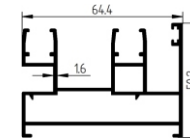
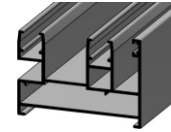

Premium Type
 Section Number 1038
 Weight (kg/mt) 1.317

CARDINAL-29 THREE TRACK

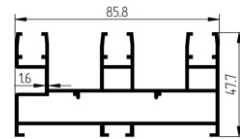
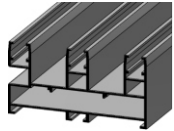

Basic Type
 Section Number 1027
 Weight (kg/mt) 1.675

CARDINAL-29 THREE TRACK

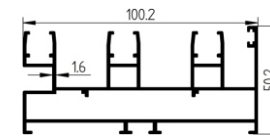
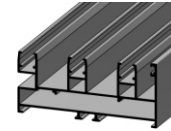

Premium Type
 Section Number 1175
 Weight (kg/mt) 1.943

CARDINAL-29 FOUR TRACK

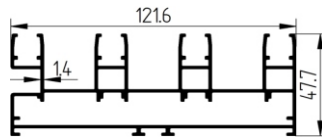
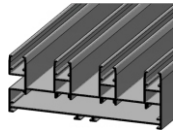

Basic Type
 Section Number 1216
 Weight (kg/mt) 2.344

CARDINAL-29 SHUTTER

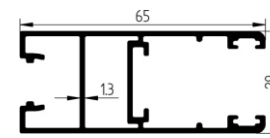
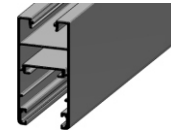

4 - 8 mm Glass Shutter
 Section Number 1028
 Weight (kg/mt) 0.942

CARDINAL-29 SHUTTER

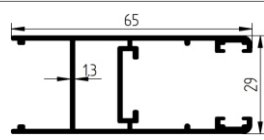
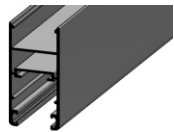

5 - 22 mm Glass Shutter
 Section Number 1096
 Weight (kg/mt) 0.849

CARDINAL-29 SHUTTER

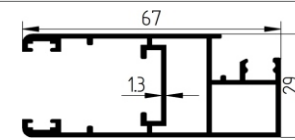
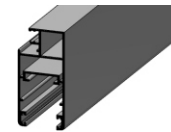

Mosquito Screen Shutter
 Section Number 1035
 Weight (kg/mt) 0.982

CARDINAL-29 INTERLOCK CLIP

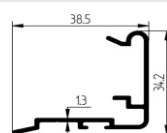
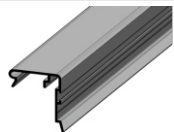

Universal Clip
 Section Number 1002
 Weight (kg/mt) 0.361

CARDINAL-29 TRACK RAIL CAP

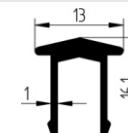
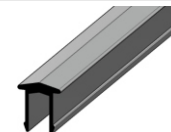

"V" Type
 Section Number 1107
 Weight (kg/mt) 0.156

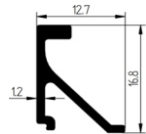
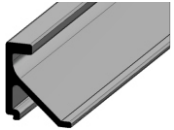
CARDINAL-29 CLIP

Mosquito Shutter Clip
 Section Number 1093
 Weight (kg/mt) 0.140

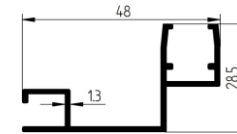
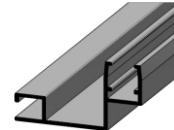
CARDINAL-29 ADDITIONAL TRACK

Mosquito Track Bracket
 Section Number 1067
 Weight (kg/mt) 0.455

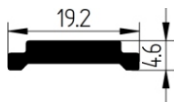
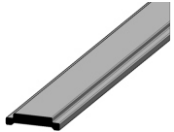
ALUMINIUM LOCKING ROD

15 x 20 Euro Groove
 Section Number 1115
 Weight (kg/mt) 0.167

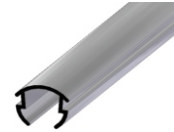
MOSQUITO CLIP

Mosquito Screen Fitting Clip
 Section Number 1269
 Weight (kg/mt) N/A

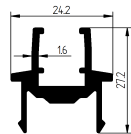
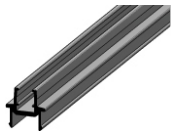
CARDINAL-29 CLIP

Meeting Section
 Section Number 1260
 Weight (kg/mt) 0.435

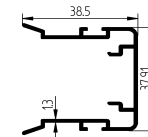
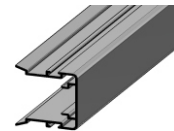
CARDINAL-29 CLIP

Double Side Interlock Clip
 Section Number 1262
 Weight (kg/mt) 0.542

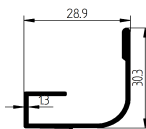
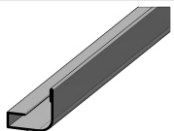
CARDINAL-29 ADDITIONAL CLIP

Track Bracket
 Section Number 1261
 Weight (kg/mt) 0.288

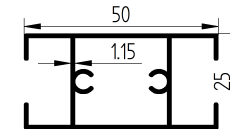
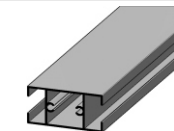
CARDINAL-29 SHUTTER MIDDLE SECTION

Single Glass Middle Shutter
 Section Number 1267
 Weight (kg/mt) 0.590

WHO WE ARE

Cardinal System is an exclusive aluminium door and window system brand of Laxmi Trading Company. Since 1981, LTC is engaged in supplying of highest quality aluminium sections with singular vision of our founder Shri Ghanshyambhai Patel. We are following the same vision, Cardinal Systems has evolved in to supplying one of the best quality aluminium system doors and windows across India with support of our esteem suppliers like Jindal Aluminium, Avigiri Urethane & rubber industries and many other brands.

We take pride in the long-standing relationships we have built with architects and builders along with prestigious window manufacturers. We are also working with many well-known national and international aluminium and hardware manufacturers as well India's top window manufacturers. We have maintained these relationships by providing efficient quality work from the beginning of a project through the completion. We are experienced in designing, engineering, ordering, delivering, and working closely with manufacturers.

We are supported by a dedicated team of skilled workforce that enables us in catering the requirements of the clients spread across the country. Our team comprises of procurement agents, quality controllers and others who work in proximity with each other to deliver the good within the stipulated time frame at the client's door step.

We pride ourselves on providing readily available more than 37 windows and doors system throughout the country with highest quality of aluminium extrusion and hardware through strong supply-chain management, regional warehouse and very strong after-sale support system.

OUR CAPACITY

30+ systems
ready stock available

150+ tons
of ready stock material

more than
9000 Sq.Ft.
warehousing space

CUSTOMER NETWORK

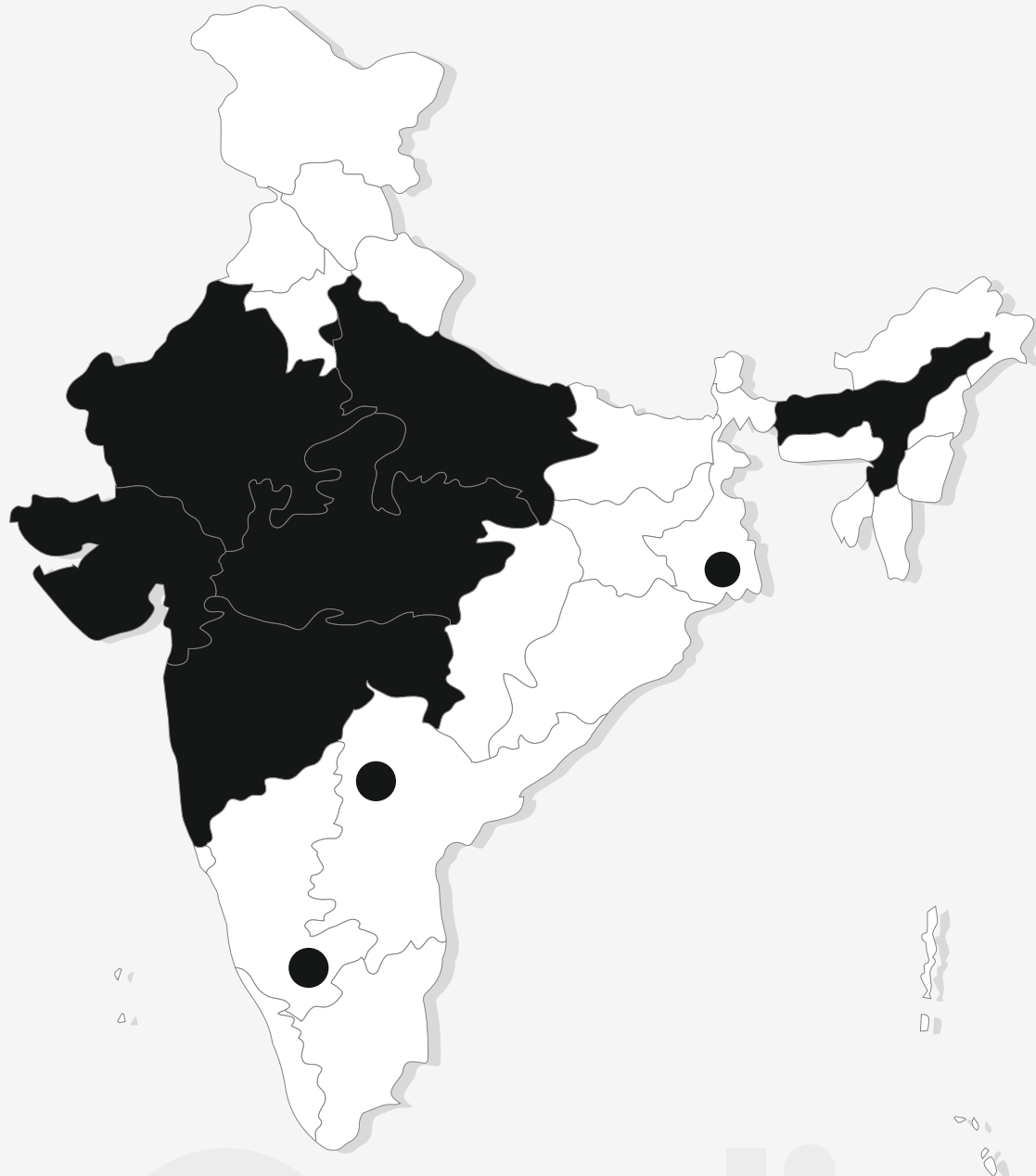

Here are the states where we are doing business

-
- Gujarat
 - Maharashtra
 - Rajasthan
 - Madhya Pradesh
 - Delhi
 - Uttar Pradesh
 - Kolkatta
 - Bangalore
 - Assam
 - Hyderabad

Cardinal



Since 1981



Laxmi Trading Company

15, Ashwarath Complex, Opp. Fortune Hotel,
Ashram Road, Ushmanpura, Ahmedabad - 380 013.
Gujarat, India.

Phone : (079) 27552997, (079) 27550151, (079) 48005361
Cell : +91 99240 11199, +91 9574511199
Email : info@ltcalu.com
Web : www.ltcalu.com