



C3568NES.35S

35MM SLIDING SYSTEM

C3568NES.35S

35MM SLIDING SYSTEM

KEY FEATURES

- Premium Quality Aluminum Profiles
- European design
- Glazing from 5 mm to 24 mm
- Single Roller Capacity 90 kg.
- Double Roller Capacity 110-180 kg.
- Smooth & Effortless in movement
- Automatic, manual concealed & Multipoint Lock System
- Provision for insect screen
- Available in Anodized, Powder Coating & Wood Finish
- Reinforced Profiles available in larger opening
- Design for Large size shutter sliding
- Alloy 6063-T6 Temper as per IS-6477 1983 for dimensional tolerances and IS-1285 1975 for chemical composition and mechanical properties
- Bug & Bugler proof window
- Dust Resistance & Better Sound Reduction
- Slim interlock shutter available for single glass & double glass sliding

TWO TRACK WITH SLIM INTERLOCK SECTION

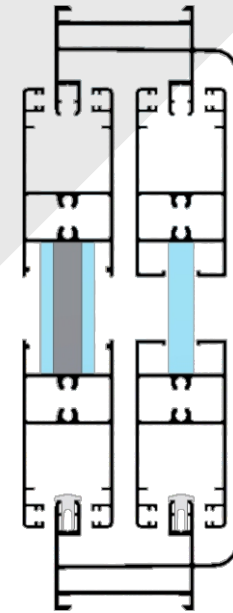
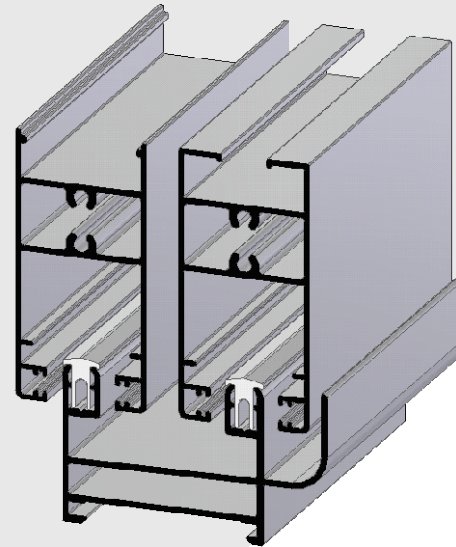

SIDE VIEW

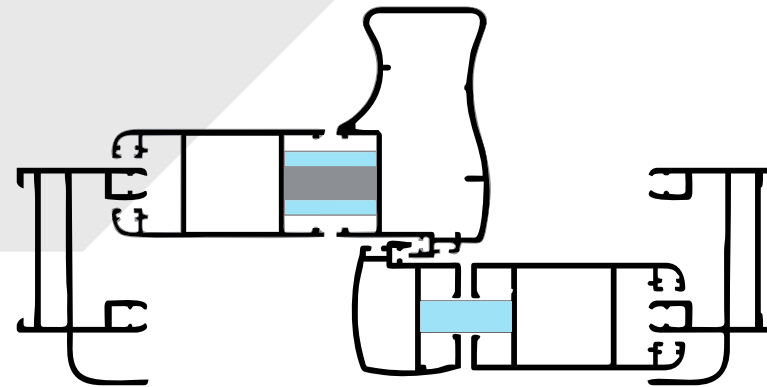

TOP VIEW



Burglar Resistance



Acoustic Performance



Wind Load Resistance



Air Tightness



Water Tightness



Impact Resistance

CARDINAL-35 TWO TRACK

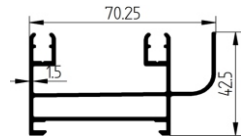
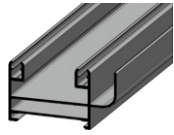

Premium Nerro Type
 Section Number 1169
 Weight (kg/mt) 1.159

CARDINAL-35 SHUTTER

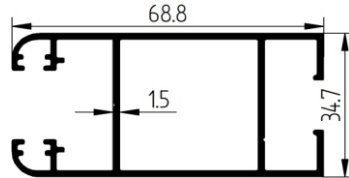
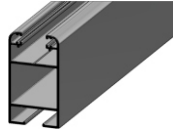

Vertical Shutter
 4 - 8 mm Glass Shutter
 Section Number 1171
 Weight (kg/mt) 1.029

CARDINAL-35 SHUTTER

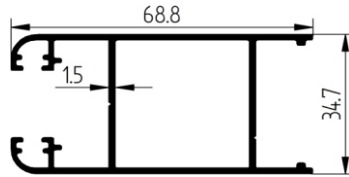
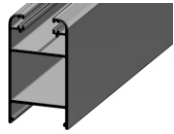

Vertical Shutter
 11 - 24 mm Glass Shutter
 Section Number 1212
 Weight (kg/mt) 0.958

CARDINAL-35 SHUTTER

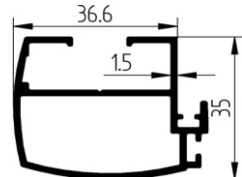
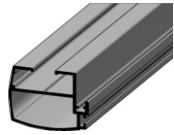

Interlock Shutter
 4 - 8 mm Glass Shutter
 Section Number 1159
 Weight (kg/mt) 0.732

CARDINAL-35 SHUTTER

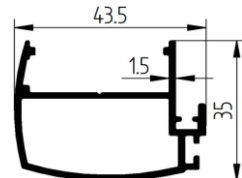
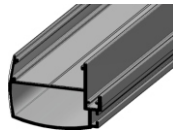

Interlock Shutter
 11 - 24 mm Glass Shutter
 Section Number 1215
 Weight (kg/mt) 0.661

CARDINAL-35 TRACK RAIL CAP

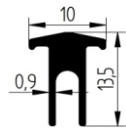
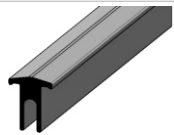

"V" Type
 Section Number 1170
 Weight (kg/mt) 0.131

CARDINAL-35 THREE TRACK

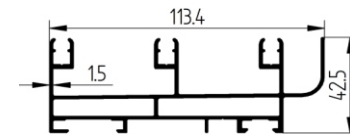
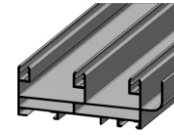

Premium Nerro Type
 Section Number 1168
 Weight (kg/mt) 1.865

CARDINAL-35 SHUTTER

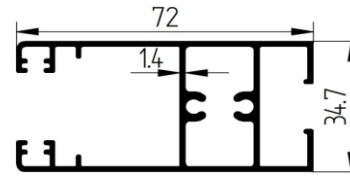
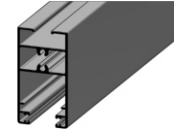

Top & Bottom Shutter
 4 - 8 mm Glass Shutter
 Section Number 1172
 Weight (kg/mt) 1.133

CARDINAL-35 SHUTTER

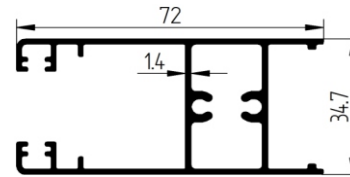
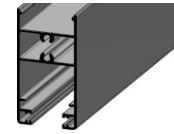

Top & Bottom Shutter
 11 - 24 mm Glass Shutter
 Section Number 1213
 Weight (kg/mt) 1.066

CARDINAL-35 SHUTTER

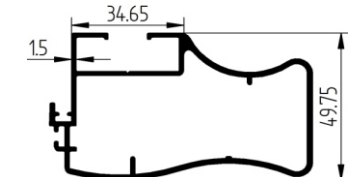
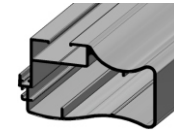

Reinforcement Interlock
 4 - 8 mm Glass Shutter
 Section Number 1173
 Weight (kg/mt) 1.370

CARDINAL-35 SHUTTER

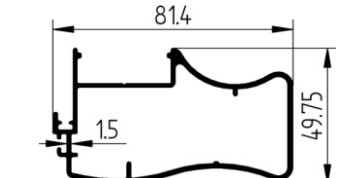
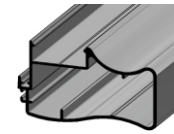

Reinforcement Interlock
 11 - 24 mm Glass Shutter
 Section Number 1214
 Weight (kg/mt) 1.300

CARDINAL-35 MIDDLE SECTION

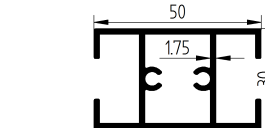
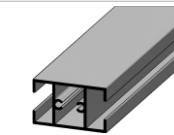

Single Glass Middle Shutter
 Section Number 1268
 Weight (kg/mt) 0.951

WHO WE ARE

Cardinal System is an exclusive aluminium door and window system brand of Laxmi Trading Company. Since 1981, LTC is engaged in supplying of highest quality aluminium sections with singular vision of our founder Shri Ghanshyambhai Patel. We are following the same vision, Cardinal Systems has evolved in to supplying one of the best quality aluminium system doors and windows across India with support of our esteem suppliers like Jindal Aluminium, Avigiri Urethane & rubber industries and many other brands.

We take pride in the long-standing relationships we have built with architects and builders along with prestigious window manufacturers. We are also working with many well-known national and international aluminium and hardware manufacturers as well India's top window manufacturers. We have maintained these relationships by providing efficient quality work from the beginning of a project through the completion. We are experienced in designing, engineering, ordering, delivering, and working closely with manufacturers.

We are supported by a dedicated team of skilled workforce that enables us in catering the requirements of the clients spread across the country. Our team comprises of procurement agents, quality controllers and others who work in proximity with each other to deliver the good within the stipulated time frame at the client's door step.

We pride ourselves on providing readily available more than 37 windows and doors system throughout the country with highest quality of aluminium extrusion and hardware through strong supply-chain management, regional warehouse and very strong after-sale support system.

OUR CAPACITY

30+ systems
ready stock available

150+ tons
of ready stock material

more than
9000 Sq.Ft.
warehousing space

CUSTOMER NETWORK

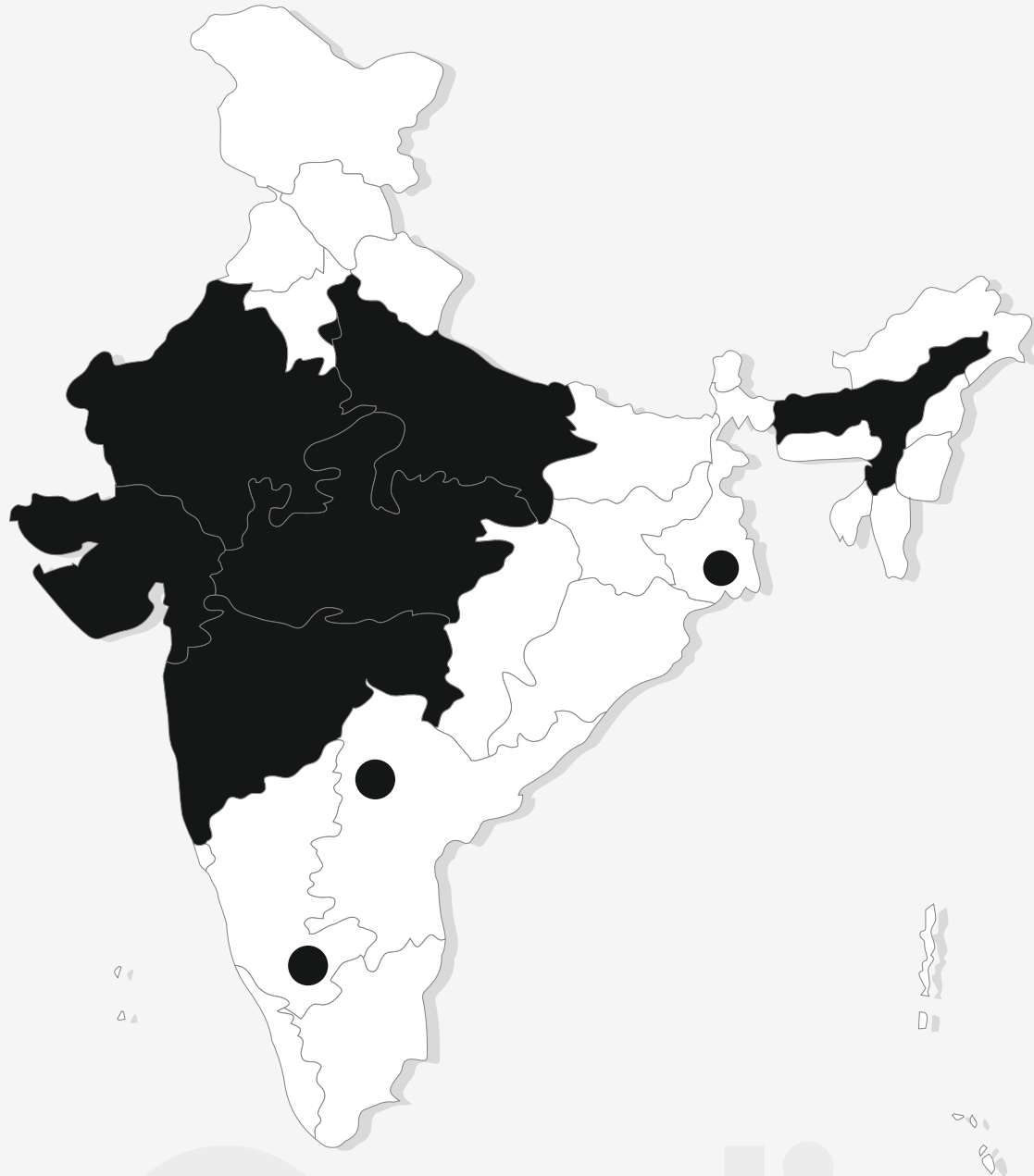

Here are the states where we are doing business

-
- Gujarat
 - Maharashtra
 - Rajasthan
 - Madhya Pradesh
 - Delhi
 - Uttar Pradesh
 - Kolkatta
 - Bangalore
 - Assam
 - Hyderabad



Since 1981



Laxmi Trading Company

15, Ashwarath Complex, Opp. Fortune Hotel,
Ashram Road, Ushmanpura, Ahmedabad - 380 013.
Gujarat, India.

Phone : (079) 27552997, (079) 27550151, (079) 48005361

Cell : +91 99240 11199, +91 9574511199

Email : info@ltcalu.com

Web : www.ltcalu.com