



C3783EGS

37MM SLIDING SYSTEM

C3783EGS

37MM SLIDING SYSTEM

KEY FEATURES

- Premium Quality Aluminum Profiles
- European design
- Glazing from 5 mm to 31 mm
- Single Roller Capacity 80 kg.
- Double Roller Capacity 110-180 kg.
- Smooth & Effortless in movement
- Automatic, manual concealed & Multipoint Lock System
- Provision for insect screen
- Available in Anodized, Powder Coating & Wood Finish
- Reinforced Profiles available in larger opening
- Design for Extra Large size shutter sliding
- Alloy 6063-T6 Temper as per IS-6477 1983 for dimensional tolerances and IS-1285 1975 for chemical composition and mechanical properties
- Bug & Bugler proof window
- Dust Resistance & Better Sound Reduction
- Slim interlock shutter available for single glass & double glass sliding

TWO TRACK SYSTEM

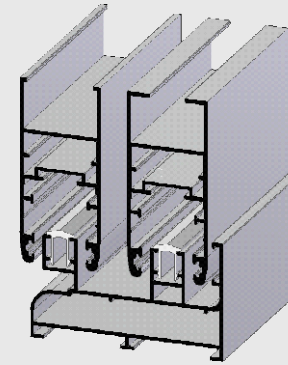

THREE TRACK WITH FLY SCREEN SHUTTER

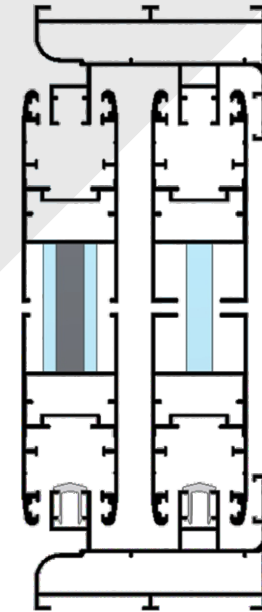
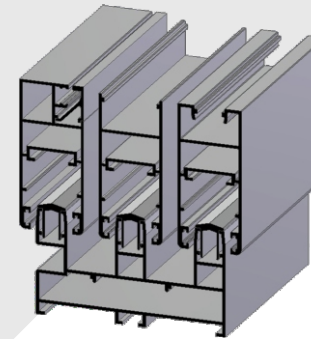

SIDE VIEW

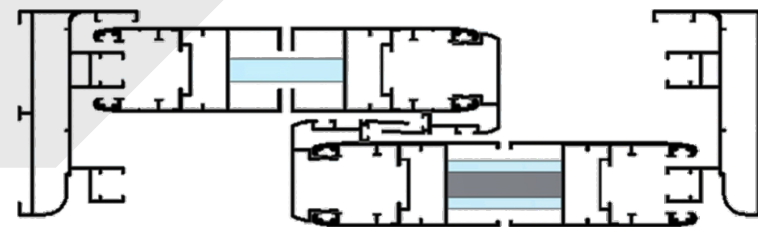

TOP VIEW



Burglar Resistance



Acoustic Performance



Wind Load Resistance



Air Tightness



Water Tightness

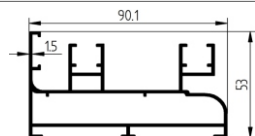
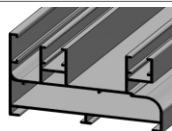

Impact Resistance

CARDINAL-37 TWO TRACK

Premium Type

Section Number 1075

Weight (kg/mt) 1.672

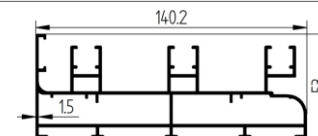
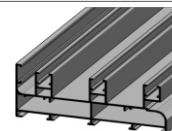
CARDINAL-37 THREE TRACK

Premium Type

Section Number 1074

Weight (kg/mt) 2.544

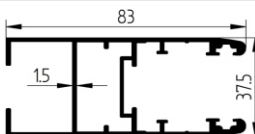
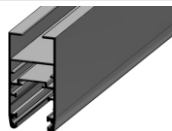
CARDINAL-37 SHUTTER

4 - 12 mm Glass Shutter

Section Number 1078

Weight (kg/mt) 1.397

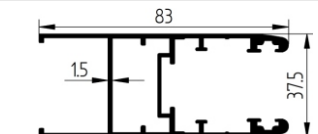
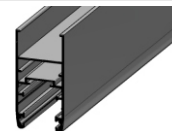
CARDINAL-37 SHUTTER

18 - 31 mm Glass Shutter

Section Number 1210

Weight (kg/mt) 1.328

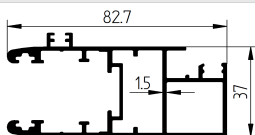
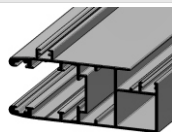
CARDINAL-37 SHUTTER

Mosquito Screen Shutter

Section Number 1259

Weight (kg/mt) 1.515

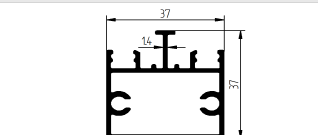
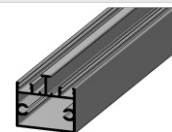
CARDINAL-37 SHUTTER

Mosquito Middle Shutter

Section Number 1256

Weight (kg/mt) 0.751

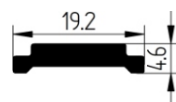
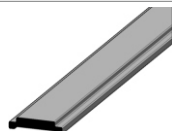
ALUMINIUM LOCKING ROD

15 x 20 Euro Groove

Section Number 1115

Weight (kg/mt) 0.167

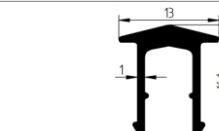
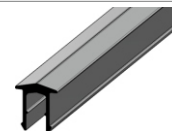
CARDINAL-37 TRACK RAIL CAP

"V" Type

Section Number 1092

Weight (kg/mt) 0.151

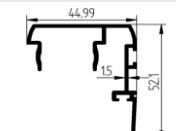
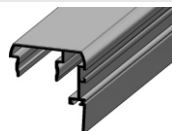
CARDINAL-37 INTERLOCK CLIP

Shutter Interlock Clip

Section Number 1209

Weight (kg/mt) 0.685

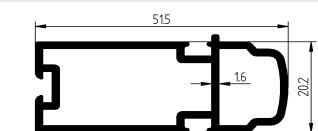
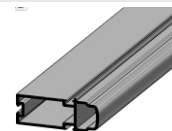
CARDINAL-37 CLIP

Meeting Section

Section Number 1258

Weight (kg/mt) 0.736

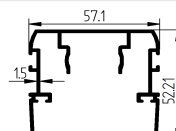
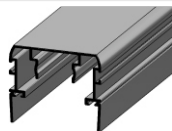
CARDINAL-37 CLIP

Double Side Interlock Clip

Section Number 1257

Weight (kg/mt) 1.038

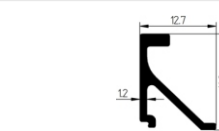
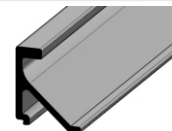
MOSQUITO SHUTTER CLIP

Universal Clip

Section Number 1093

Weight (kg/mt) 0.140

WHO WE ARE

Cardinal System is an exclusive aluminium door and window system brand of Laxmi Trading Company. Since 1981, LTC is engaged in supplying of highest quality aluminium sections with singular vision of our founder Shri Ghanshyambhai Patel. We are following the same vision, Cardinal Systems has evolved in to supplying one of the best quality aluminium system doors and windows across India with support of our esteem suppliers like Jindal Aluminium, Avigiri Urethane & rubber industries and many other brands.

We take pride in the long-standing relationships we have built with architects and builders along with prestigious window manufacturers. We are also working with many well-known national and international aluminium and hardware manufacturers as well India's top window manufacturers. We have maintained these relationships by providing efficient quality work from the beginning of a project through the completion. We are experienced in designing, engineering, ordering, delivering, and working closely with manufacturers.

We are supported by a dedicated team of skilled workforce that enables us in catering the requirements of the clients spread across the country. Our team comprises of procurement agents, quality controllers and others who work in proximity with each other to deliver the good within the stipulated time frame at the client's door step.

We pride ourselves on providing readily available more than 37 windows and doors system throughout the country with highest quality of aluminium extrusion and hardware through strong supply-chain management, regional warehouse and very strong after-sale support system.

OUR CAPACITY

30+ systems
ready stock available

150+ tons
of ready stock material

more than
9000 Sq.Ft.
warehousing space

CUSTOMER NETWORK

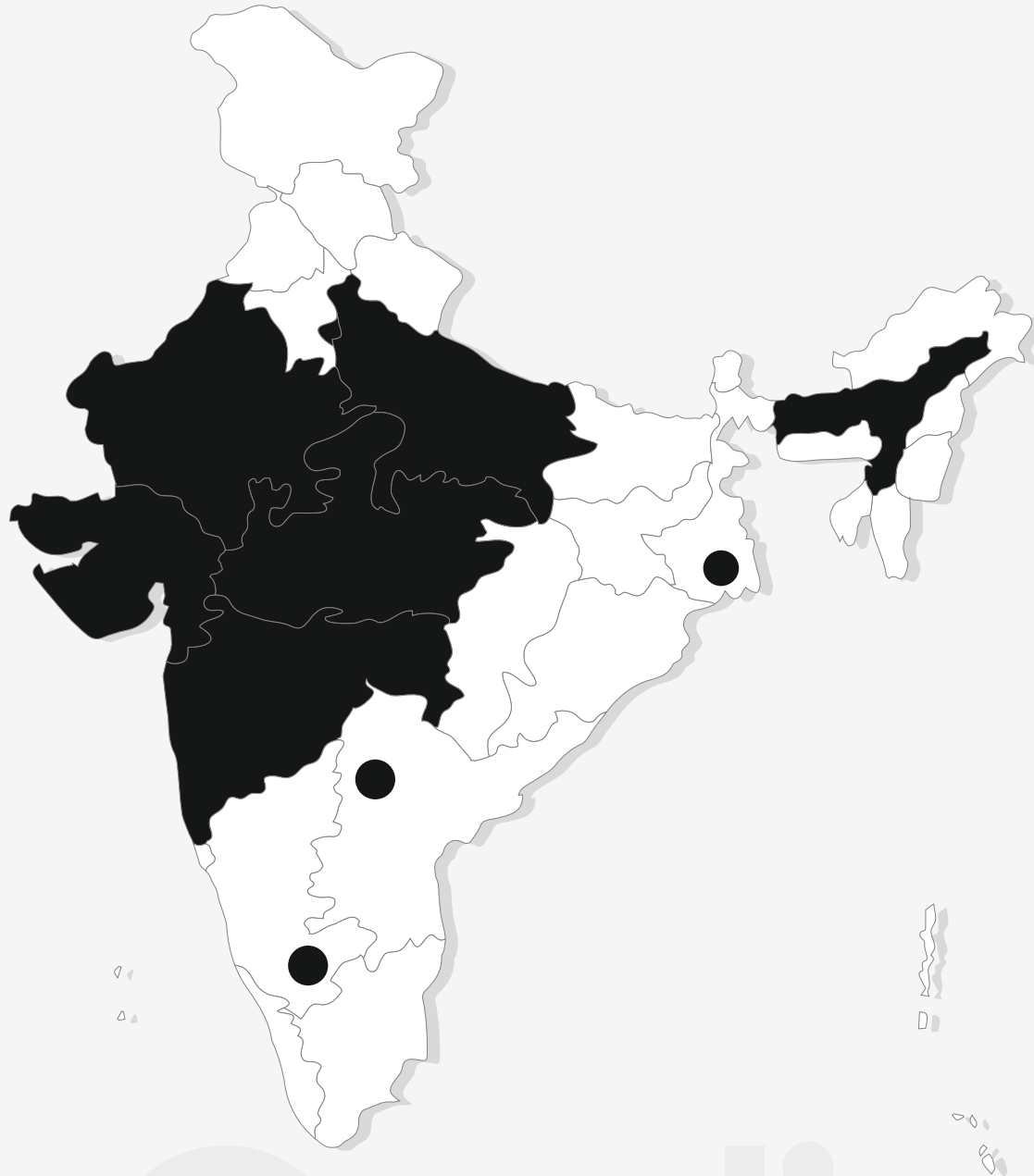

Here are the states where we are doing business

-
- Gujarat
 - Maharashtra
 - Rajasthan
 - Madhya Pradesh
 - Delhi
 - Uttar Pradesh
 - Kolkatta
 - Bangalore
 - Assam
 - Hyderabad



Since 1981



Laxmi Trading Company

15, Ashwarath Complex, Opp. Fortune Hotel,
Ashram Road, Ushmanpura, Ahmedabad - 380 013.
Gujarat, India.

Phone : (079) 27552997, (079) 27550151, (079) 48005361
Cell : +91 99240 11199, +91 9574511199
Email : info@ltcalu.com
Web : www.ltcalu.com